



# INSTALLATION MANUAL

## MARINER<sup>®</sup> OUTDOOR SPEAKERS

MARINER 54 | MARINER 54 SST | MARINER 56

MARINER 64 | MARINER 64 SST | MARINER 66 | MARINER 86

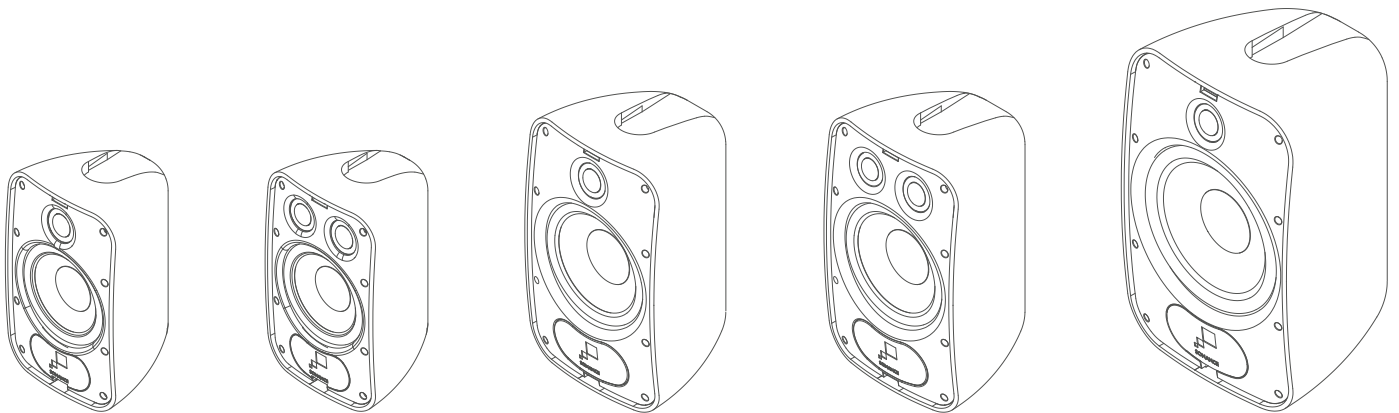

## PRODUCT DESCRIPTION

Thank you for purchasing Sonance Mariner weather-resistant speakers.

When properly installed, these speakers will give you many years of outdoor entertainment pleasure. To get the most out of your new speakers, please read this manual thoroughly before you begin installation.

The directions in this manual apply to the following models: MARINER 54, MARINER 54 SST, MARINER 56, MARINER 64, MARINER 64 SST, MARINER 66, and MARINER 86

## BOX & CONTENTS

Sonance MARINER 54, MARINER 56, MARINER 64, MARINER 66, and MARINER 86 2-Way speaker boxes contain: (2) Speakers, (2) Speaker Grilles, (2) FastMount® Brackets, and (2) Wiring Terminal Covers.

Sonance MARINER 54 SST, and MARINER 64 SST, Single Stereo speaker boxes contain: (1) Speaker, (1) Speaker Grille, (1) FastMount® Bracket, and (1) Wiring Terminal Cover.

## SPEAKER PLACEMENT

Mariner speakers are highly weather-resistant, and when mounted outdoors will perform exceptionally well for years even under adverse weather conditions.

The Mariner FastMount bracket system makes it easy to mount the speakers in a variety of positions and locations: (see figure 1).

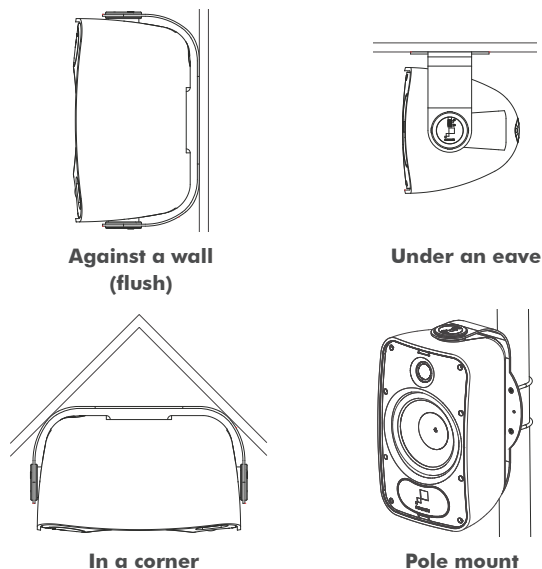

FIGURE 1:  
SPEAKER PLACEMENT

The best performance is obtained by placing the speakers at ear level, facing the listeners.

- If you are mounting the speakers above or below ear level, pivot them up or down to direct the sound towards the listeners.
- You can orient the speakers either horizontally or vertically without affecting the sound quality.

## TYPES OF WIRE

When installing Sonance Mariner Outdoor Speakers careful consideration should be made when determining speaker placement and what gauge wire should be used. Please refer to the wiring chart (see figure 2) to determine which size wire to use over the given distance between the amplifier/receiver and the speakers.

WIRE GAUGE CHART	
WIRE GAUGE	DISTANCE
18 Gauge	Up to 100 feet (30 meters)
16 Gauge	Up to 150 feet (45 meters)
14 Gauge	Up to 250 feet (80 meters)
12 Gauge	Up to 400 feet (122 meters)
10 Gauge	Up to 650 feet (198 meters)

FIGURE 2: WIRE GAUGE CHART

## CONNECTING AND ASSEMBLING THE SPEAKERS

**WARNING: TURN THE AMPLIFIER'S POWER OFF UNTIL YOU HAVE COMPLETED ALL OF THE CONNECTIONS AND HAVE DETERMINED THAT THEY ARE CORRECT. (IF THE AMP'S AC PLUG IS ACCESSIBLE WE RECOMMEND THAT YOU UNPLUG IT FROM THE WALL OUTLET TO AVOID ACCIDENTAL TURN-ON AND POSSIBLE DAMAGE TO THE AMPLIFIER.)**

1. In most cases you will be able to attach the FastMount brackets directly to the mounting surface. Run the speaker wires from the amplifier to the speaker locations and through the holes in the brackets and mounting bases, if used (see figure 3).

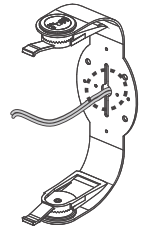

FIGURE 3:  
PASS WIRE  
THROUGH HOLE

**NOTE: TO INCREASE WATER RESISTANCE AND MAKE INSTALLATION EASIER, THE SPEAKER WIRE TERMINALS ARE LOCATED ON THE MARINER SPEAKERS' FRONT PANEL. BE SURE TO LEAVE ENOUGH WIRE AT THE SPEAKER LOCATION TO FEED THROUGH THE TUNNEL IN THE SPEAKER ENCLOSURE AND CONNECT TO THE TERMINALS ON THE FRONT.**

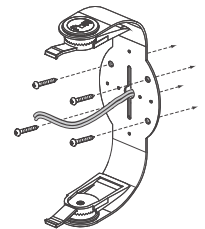

FIGURE 4:  
ATTACH BRACKET

2. Attach the FastMount brackets to the mounting surface using hardware (not included) that is appropriate for the type of surface (see figure 4).

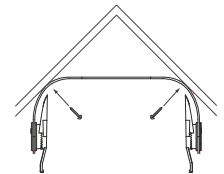

FIGURE 5:  
CORNER MOUNTING

- If the installation requires that the speaker be mounted in a corner, attach the bracket with hardware through the slots in the angled corners (see figure 5).

3. If the installation requires that the speaker be mounted on a pole you can attach the FastMount brackets to the pole using 2.5" U-bolts (not included) (see figure 6).

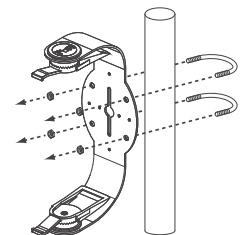

FIGURE 6:  
ATTACHING THE  
BRACKET TO A POLE

4. Feed the speaker wires from the bracket into the wire entry grommet on the back of the speaker, through the wire tunnel and out the opening on the speaker's front panel (see figure 7).

- The grommet forms a water-resistant seal around the speaker wire.
- Make sure there is enough slack in the wire to allow the speaker to pivot on the bracket.

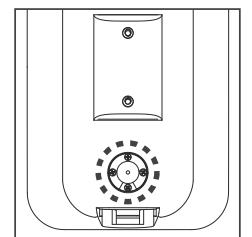

FIGURE 7:  
WIRE ENTRY GROMMET

5. Slide the speaker onto the bracket and firmly snap into place. Pull enough wire through the front of the speaker to allow connection to the terminals (see figure 8).

NOTE: BE SURE THAT THE BRACKET CLIPS SNAP COMPLETELY INTO PLACE TO PREVENT ANY BLOCKAGE WITHIN THE SPEAKER PERIMETER WHERE THE GRILLE IS TO BE INSERTED.

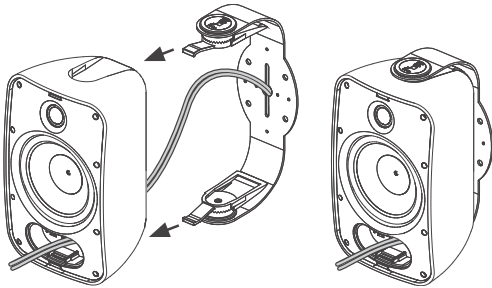

FIGURE 8:  
ATTACH SPEAKERS  
TO BRACKETS

NOTE: BE SURE THAT THE BRACKET CLIPS SNAP COMPLETELY INTO PLACE TO PREVENT ANY BLOCKAGE WITHIN THE SPEAKER PERIMETER WHERE THE GRILLE IS TO BE INSERTED.

6. Connect the speaker wires to the speaker's terminals:
- Strip about .5" of insulation from each conductor and twist the strands together or tin them with solder.

7. Connect the speaker wires to the speaker's terminals:

- Strip about .5" of insulation from each conductor and twist the strands together or tin them with solder.
- Press-down on the tops of the connectors to open them.
- Insert the wires into the connector holes (see figure 9).
- Release the connectors.

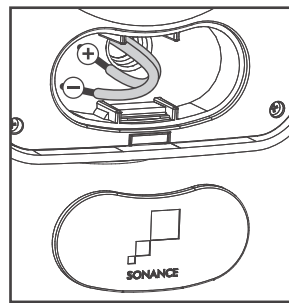

FIGURE 9:  
CONNECTION TERMINALS

- The binding post connectors can accept wire up to 14 gauge.
- Double-check that you connected all of the wires properly (amplifier '+' to speaker '+'; amplifier '-' to speaker '-') at all connections.

IMPORTANT: BE SURE NOT TO LET ANY STRAY '+' AND '-' WIRES TOUCH EACH OTHER. TOUCHING WIRES CAN CAUSE A SHORT-CIRCUIT THAT COULD DAMAGE YOUR AMPLIFIER.

- Fit the wiring connector cover into the recess in the speaker's front panel. The cover should fit tightly, but can be removed and replaced if the speaker needs to be disconnected (see figure 10).
- Fit the grille onto the speaker by aligning the edges of the grille with the groove of the speaker face perimeter and pressing firmly until it is snugly in place.. (see figure 11).

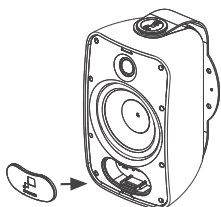

FIGURE 10:  
ATTACH THE  
CONNECTOR COVER

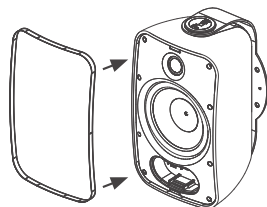

FIGURE 11:  
ATTACH THE GRILLE

NOTE: ALL SONANCE MARINER SPEAKERS ARE COMPATIBLE WITH OMNIMOUNT STAINLESS STEEL 15.0 C AND 15.0 W SERIES SPEAKER BRACKETS. FOR MORE INFORMATION CONTACT YOUR SONANCE AUTHORIZED DEALER OR GO TO WWW.OMNIMOUNT.COM.

## REMOVING THE SPEAKER

To remove the speaker from the FastMount bracket, first use the provided grille pick to pluck the grille at each corner and gently pull until the grille is freed from the grooves of the speaker face. Next, use your thumbs to press outward on the top and bottom tabs of the speaker face, releasing the clips of the bracket. While pressing the tabs, pull gently on the speaker toward yourself until it is removed from the bracket.

## PIVOTING THE SPEAKER

You can rotate the speaker in the bracket to direct the sound towards the listeners.

- Unlock the slide locks on the speaker pivots by moving them towards the rear of the speaker (see figure 12).
- Rotate the speakers to the desired position.
- Lock the slide locks by moving them towards the front of the speaker.

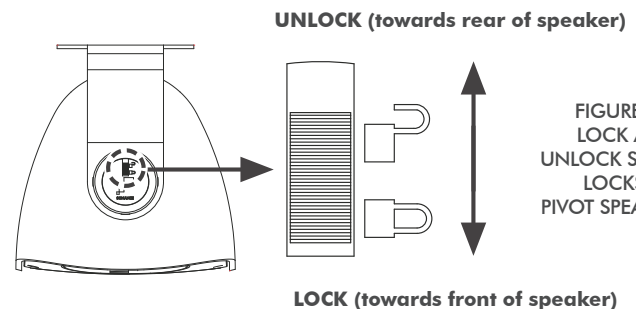

FIGURE 12:  
LOCK AND  
UNLOCK SLIDE  
LOCKS TO  
PIVOT SPEAKER

## PAINTING THE SPEAKER AND GRILLE

All Mariner speakers feature a tough polypropylene enclosure that can be painted. Sonance recommends using a weather-resistant outdoor paint and a spray gun to paint the Mariner speakers.

- If it has already been installed, remove the grille from the speaker.
- To protect the speaker driver units during painting, place the grille on a piece of cardboard and trace around its outline. Then cut the cardboard just inside of the trace line and fit this "paint plug" into the speaker's baffle. (Be careful not to damage the driver components while fitting the paint plug.)
- Paint the speaker the desired color according to the paint manufacturer's instructions. Remove the paint plug after the paint has thoroughly dried.
- Paint the grille separately from the speaker using very thin paint (5:1 thinner:paint ratio). Avoid plugging the grille holes with excess paint.
- After the paint has thoroughly dried, re-attach the grille to the speaker.

## SPECIFICATIONS

### Mariner 54

Tweeter:	1" (25mm) cloth dome, Ferrofluid cooled, in acoustic back chamber
Woofer:	5.25" (130mm) textured polypropylene cone with a Santoprene surround
Frequency Response:	65Hz - 20kHz $\pm$ 3dB
Impedance:	8 ohms nominal; 6 ohms minimum
Power Handling:	5 watts minimum; 60 watts maximum
Sensitivity:	87dB SPL (2.83V/1 meter)
Environmental:	Conforms to Mil Spec 810 for humidity, salt spray, temperature and UV, IP-66 waterproof rating
Environment Temp:	-13° - 149°F (-25°C - 65°C)
Dimensions (WxHxD):	6.36" x 10.08" x 5.68" (162mm x 256mm x 144mm)
Grille:	Perforated aluminum
Shipping Weight:	12 lbs. (5.5kg) pair

### Mariner 54 SST

Tweeter:	Two 1" (25mm) cloth dome, Ferrofluid cooled, in acoustic back chamber
Woofer:	5.25" (130mm) textured polypropylene cone with a Santoprene surround, dual voice coil
Frequency Response:	65Hz - 20kHz $\pm$ 3dB
Impedance:	8 ohms nominal; 6 ohms minimum
Power Handling:	5 watts minimum; 60 watts maximum
Sensitivity:	87dB SPL (2.83V/1 meter)
Environmental:	Conforms to Mil Spec 810 for humidity, salt spray, temperature and UV, IP-66 waterproof rating
Environment Temp:	-13° - 149°F (-25°C - 65°C)
Dimensions (WxHxD):	6.36" x 10.08" x 5.68" (162mm x 256mm x 144mm)
Grille:	Perforated aluminum
Shipping Weight:	6 lbs. (2.8kg) each

### Mariner 56

Tweeter:	1" (25mm) powder-coated aluminum dome, Ferrofluid cooled, in acoustic back chamber
Woofer:	5.25" (130mm) Kevlar/Nomex laminated cone with a Santoprene surround
Frequency Response:	60Hz - 20kHz $\pm$ 3dB
Impedance:	8 ohms nominal; 6 ohms minimum
Power Handling:	5 watts minimum; 70 watts maximum
Sensitivity:	88dB SPL (2.83V/1 meter)
Environmental:	Conforms to Mil Spec 810 for humidity, salt spray, temperature and UV, IP-66 waterproof rating
Environment Temp:	-13° - 149°F (-25°C - 65°C)
Dimensions (WxHxD):	6.36" x 10.08" x 5.68" (162mm x 256mm x 144mm)
Grille:	Perforated aluminum
Shipping Weight:	13 lbs. (6kg) pair

### Mariner 64

Tweeter:	1" (25mm) cloth dome, Ferrofluid cooled, in acoustic back chamber
Woofer:	6.5" (165mm) textured polypropylene cone with a Santoprene surround
Frequency Response:	55Hz - 20kHz $\pm$ 3dB
Impedance:	8 ohms nominal; 6 ohms minimum
Power Handling:	5 watts minimum; 80 watts maximum
Sensitivity:	89dB SPL (2.83V/1 meter)
Environmental:	Conforms to Mil Spec 810 for humidity, salt spray, temperature and UV, IP-66 waterproof rating
Environment Temp:	-13° - 149°F (-25°C - 65°C)
Dimensions (WxHxD):	7.51" x 12.14" x 6.86" (191mm x 308mm x 174mm)
Grille:	Perforated aluminum
Shipping Weight:	14 lbs. (6.4kg) pair

### Mariner 64 SST

Tweeter:	Two 1" (25mm) cloth dome, Ferrofluid cooled, in acoustic back chamber
Woofer:	6.5" (165mm) textured polypropylene cone with a Santoprene surround, dual voice coil
Frequency Response:	55Hz - 20kHz $\pm$ 3dB
Impedance:	8 ohms nominal; 6 ohms minimum
Power Handling:	5 watts minimum; 80 watts maximum
Sensitivity:	89dB SPL (2.83V/1 meter)
Environmental:	Conforms to Mil Spec 810 for humidity, salt spray, temperature and UV, IP-66 waterproof rating
Environment Temp:	-13° - 149°F (-25°C - 65°C)
Dimensions (WxHxD):	7.51" x 12.14" x 6.86" (191mm x 308mm x 174mm)
Grille:	Perforated aluminum
Shipping Weight:	7 lbs. (3.2kg) each

### Mariner 66

Tweeter:	1" (25mm) powder-coated aluminum dome, Ferrofluid cooled, in acoustic back chamber
Woofer:	6.5" (165mm) Kevlar/Nomex laminated cone with a Santoprene surround
Frequency Response:	50Hz - 20kHz $\pm$ 3dB
Impedance:	8 ohms nominal; 6 ohms minimum
Power Handling:	5 watts minimum; 100 watts maximum
Sensitivity:	90dB SPL (2.83V/1 meter)
Environmental:	Conforms to Mil Spec 810 for humidity, salt spray, temperature and UV, IP-66 waterproof rating
Environment Temp:	-13° - 149°F (-25°C - 65°C)
Dimensions (WxHxD):	7.51" x 12.14" x 6.86" (191mm x 308mm x 174mm)
Grille:	Perforated aluminum
Shipping Weight:	17 lbs. (7.7kg) pair

### Mariner 86

Tweeter:	1" (25mm) powder-coated aluminum dome, Ferrofluid cooled, in acoustic back chamber
Woofer:	8" (203mm) Kevlar/Nomex laminated cone with a Santoprene surround
Frequency Response:	45Hz - 20kHz $\pm$ 3dB
Impedance:	8 ohms nominal; 6 ohms minimum
Power Handling:	5 watts minimum; 125 watts maximum
Sensitivity:	91dB SPL (2.83V/1 meter)
Environmental:	Conforms to Mil Spec 810 for humidity, salt spray, temperature and UV, IP-66 waterproof rating
Environment Temp:	-13° - 149°F (-25°C - 65°C)
Dimensions (WxHxD):	9.01" x 14.02" x 8.58" (229mm x 356mm x 218mm)
Grille:	Perforated aluminum
Shipping Weight:	20lbs. (9kg) pair

## LIMITED FIVE (5) YEAR WARRANTY

Sonance warrants to the first end-user purchaser that this Sonance-brand product ("Product"), when purchased from an authorized Sonance Dealer/Distributor, will be free from defective workmanship and materials for the life of the Product, except for the grille, which is warranted for five (5) years. Sonance will at its option and expense either repair the defect or replace the Product with a new or remanufactured Product or a reasonable equivalent.

## EXCLUSIONS

TO THE EXTENT PERMITTED BY LAW, THE WARRANTY SET FORTH ABOVE IS IN LIEU OF, AND EXCLUSIVE OF, ALL OTHER WARRANTIES, EXPRESS OR IMPLIED, AND IS THE SOLE AND EXCLUSIVE WARRANTY PROVIDED BY SONANCE. ALL OTHER EXPRESS AND IMPLIED WARRANTIES, INCLUDING THE IMPLIED WARRANTIES OF MERCHANTABILITY, IMPLIED WARRANTY OF FITNESS FOR USE, AND IMPLIED WARRANTY OF FITNESS FOR A PARTICULAR PURPOSE ARE SPECIFICALLY EXCLUDED.

No one is authorized to make or modify any warranties on behalf of Sonance.

The warranty stated above is the sole and exclusive remedy and Sonance's performance shall constitute full and final satisfaction of all obligations, liabilities and claims with respect to the Product. IN ANY EVENT, SONANCE SHALL NOT BE LIABLE FOR CONSEQUENTIAL, INCIDENTAL, ECONOMIC, PROPERTY, BODILY INJURY, OR PERSONAL INJURY DAMAGES ARISING FROM THE PRODUCT, ANY BREACH OF THIS WARRANTY OR OTHERWISE.

This warranty statement gives you specific legal rights, and you may have other rights which vary from state to state. Some states do not allow the exclusion of implied warranties or limitations of remedies, so the above exclusions and limitations may not apply. If your state does not allow disclaimer of implied warranties, the duration of such implied warranties is limited to period of Sonance's express warranty.

Your Product Model & Description: Sonance Mariner Series Speakers

Additional Limitations and Exclusions from Warranty Coverage: The warranty described above is non-transferable, applies only to the initial installation of the Product, does not include installation of any repaired or replaced Product, does not include damage to allied or associated equipment which may result for any reason from use with this Product, and does not include labor or parts caused by accident, disaster, negligence, improper installation, misuse (e.g. overdriving the amplifier or speaker, excessive heat or cold or humidity, outdoor installation), or from service or repair which has not been authorized by Sonance.

Obtaining Authorized Service: To qualify for the warranty, you must contact your authorized Sonance Dealer/Installer or call Sonance Customer Service at (949) 492-7777, must obtain a return merchandise number (RMA), and must deliver the Product to Sonance shipping prepaid during the warranty period, together with the original sales receipt, or invoice or other satisfactory proof of purchase.

©2018 Sonance. All rights reserved. Sonance and FastMount are registered trademarks of Dana Innovations. Due to continuous product improvement, all features and specifications are subject to change without notice. For the latest Sonance product specification information visit our website: [www.sonance.com](http://www.sonance.com)



SONANCE • 991 Calle Amanecer  
San Clemente, CA 92673 USA  
(949) 492-7777 • FAX: (949) 361-5151  
[www.sonance.com](http://www.sonance.com)