



SONANCE GARDEN SERIES
SGS SYSTEM
INSTRUCTION MANUAL

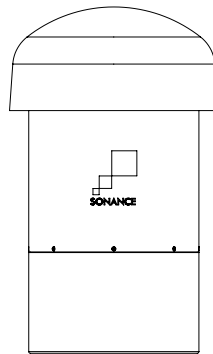
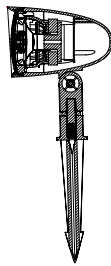

TABLE OF CONTENTS

Design and Features	2
Introduction	2
Box Contents	2
Speaker Layout Planning	2
Types of Wire	3
Speaker Installation	3
Connecting the Speakers	3
Recommended Tools	5
Speaker Wire Connection	5
Subwoofer Wire Connection	6
Specifications	7
Warranty	8

Introduction

Thank you for purchasing the SONANCE GARDEN SERIES SGS SYSTEM. When properly installed, this system will provide you with years of outdoor entertainment pleasure. To get the most out of your new system, please read this manual thoroughly before you begin installation.

Box Contents

SONANCE SGS SYSTEM box contains:

- (8) Satellite speakers with vertical pivoting knuckle
- (8) Removeable speaker stakes with 1/2" NPS threading
- (1) In-Ground subwoofer

Speaker Layout Planning

The SONANCE SGS SYSTEM is designed to deliver a seamless, evenly dispersed sound field in an 'open air' environment. A daisy chain of multiple satellite speakers and a subwoofer should be strategically placed to create even, balanced coverage, minimizing 'hot spots' and 'cold spots' around the outdoor entertainment area (see Figure 1).

The satellite speakers should be placed from 8 to 10 feet (2.4 - 3 meters) apart for best coverage. To achieve the best balance between the satellites and subwoofer, the subwoofer should be placed as close to the center of the satellites as possible.

If more bass is required, placing the subwoofer near a wall or other solid structure will greatly reinforce the low bass frequencies. In some cases you may want to place the subwoofer closer to your primary listening position or add a second Sonance Garden Series subwoofer.

The satellites in the SONANCE SGS SYSTEM individually present a 30 ohm load to the amplifier. When 4 of them are connected on each amplifier channel in parallel, the load to the amplifier is approximately 7.5 ohms. The satellites and subwoofer both feature internal crossovers so the subwoofers impedance is not combined with the satellites. The overall load presented to your amplifier by the SONANCE SGS SYSTEM will be around 7.5 ohms nominal.

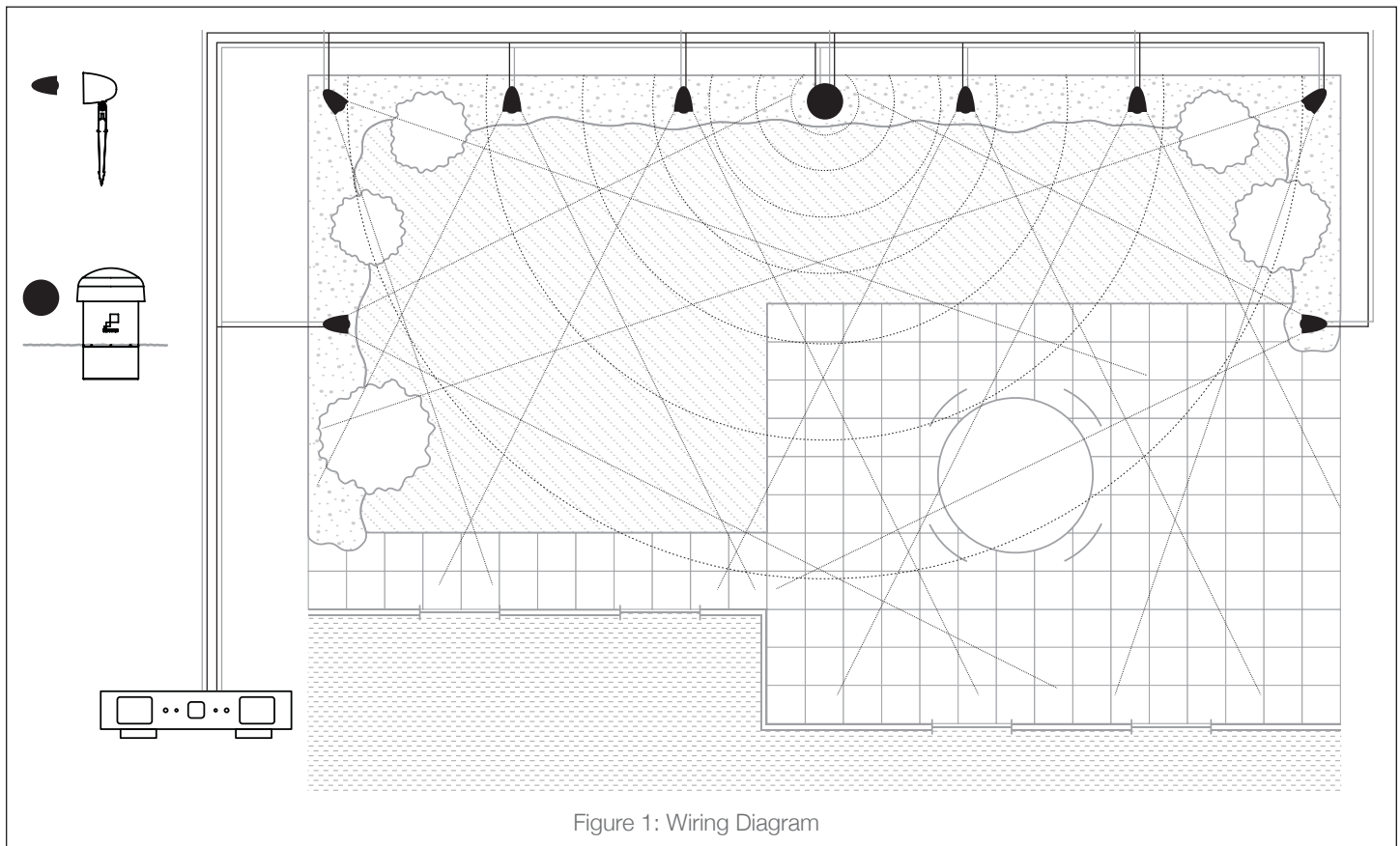
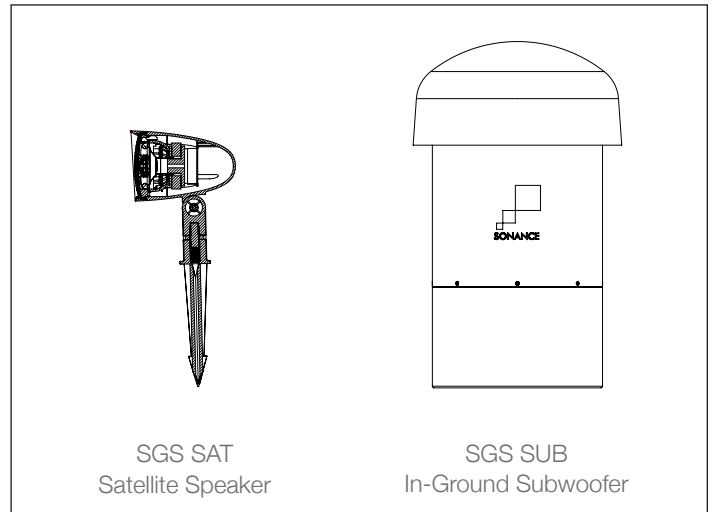

Figure 1: Wiring Diagram

Types of Wire

Color-coded, 14/4 direct-burial speaker wire is recommended.

NOTE: PLEASE REFER TO THE WIRING CHART BELOW TO DETERMINE WHICH SIZE WIRE TO USE OVER A GIVEN DISTANCE.

WIRE GAUGE CHART	
Wire Gauge	DISTANCE
18 Gauge	Up to 100 feet (30 meters)
16 Gauge	Up to 150 feet (45 meters)
14 Gauge	Up to 250 feet (80 meters)

Best Practice: '14/4' refers to 14 gauge, 4-conductor wire. It is important to use only 'direct burial' wire to maintain long-term signal integrity and prevent corrosion. Using individual conductors with different colors makes it easy to identify and access both amplifier channels. Low voltage lighting wire can also be used but is only sold as a 2 conductor wire. If using a 2 conductor wire, then run two pairs of wires; one for each amplifier channel (Right/Left).

Speaker Installation

1. Place the 8 satellites and 1 subwoofer in their approximate final locations.
2. Dig a 4" to 5" trench to run the speaker wires in. Be sure to check local codes for trenching limitations.
3. Starting at the amp location or wire connection point, run the speaker wire through the trench to the first speaker location.
4. Once the speakers and subwoofer are laid out in their locations and the wiring is completed per this installation guide, stake or mount the speakers into their final locations and bury the subwoofer in its final location.

NOTE: THE SUBWOOFER REQUIRES A BURIAL SPACE THAT IS ABOUT 14" DIAMETER AND 15" DEEP. WHEN SUBWOOFER IS IN THE GROUND, ENSURE THAT THERE IS ROUGHLY 5" OF EXPOSED SUBWOOFER ENCLOSURE FROM THE SURFACE OF THE GROUND TO THE BOTTOM EDGE OF THE CANOPY. SEE FIGURE 2.

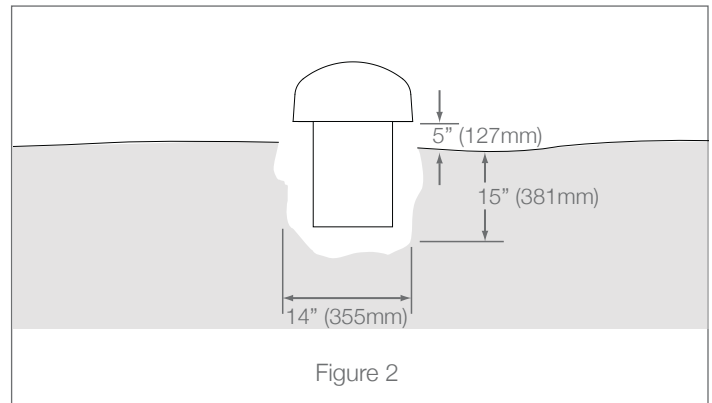

Figure 2

Connecting the Speakers

The SGS SYSTEM allows the satellite speakers to be wired together in a parallel/daisy chain configuration. In a typical system with one zone of audio, simply run a 4 conductor wire from the amplifier or connection point to the closest speaker. Once you have designated the first speaker as either left or right, continue alternating the wires between the left and right channels creating a daisy chain of stereo satellites (see Figure 3).

NOTE: THE SUBWOOFER CAN BE CONNECTED AT ANY POINT IN THE DAISY CHAIN.

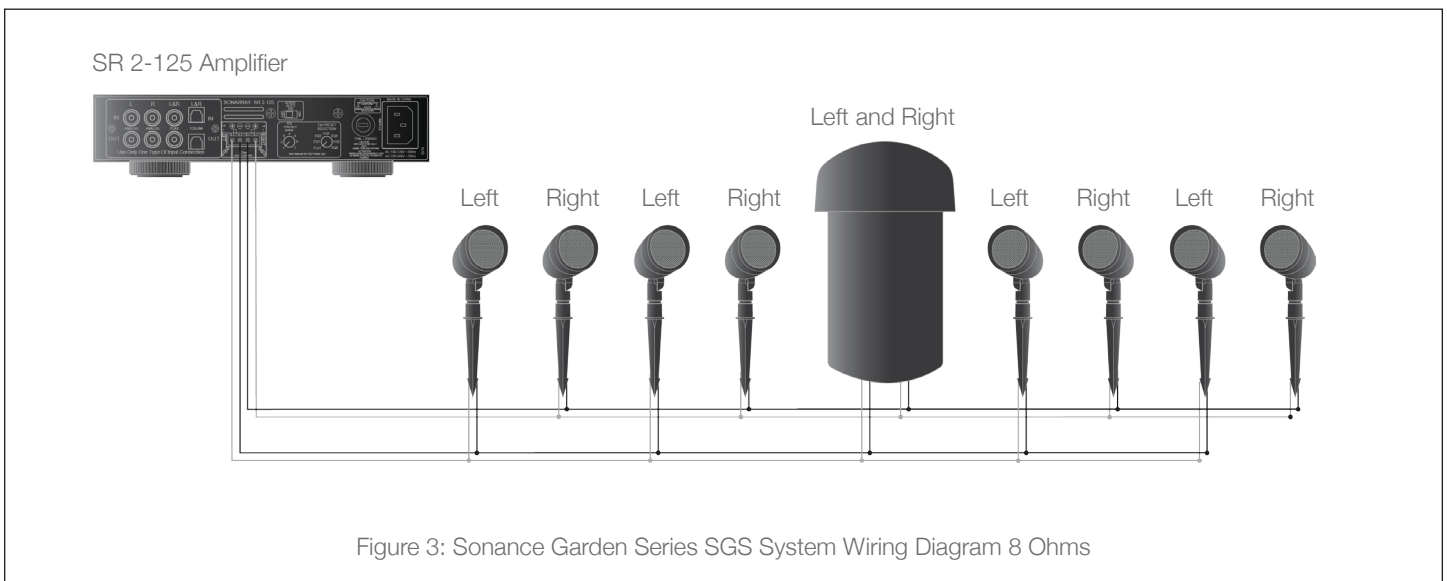
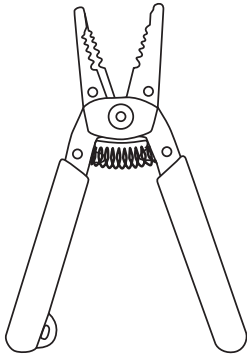
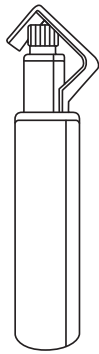

Figure 3: Sonance Garden Series SGS System Wiring Diagram 8 Ohms

Recommended Tools



Wire Stripper
accommodates up to a 12 gauge wire



Round Cable Stripper
needed when using 14/4 direct burial wire

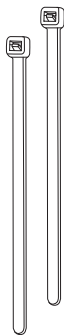

Wire Ties and Electrical Tape

Speaker Wire Connection

Connecting the speakers using 14/4 direct burial speaker wire.

1. Pull the 14/4 wire on the spool to the furthest speaker location. Leave the wire attached to the spool until the last speaker has been connected.
2. Starting at the first speaker and every speaker that follows, create a loop of wire approximately 6" in length.

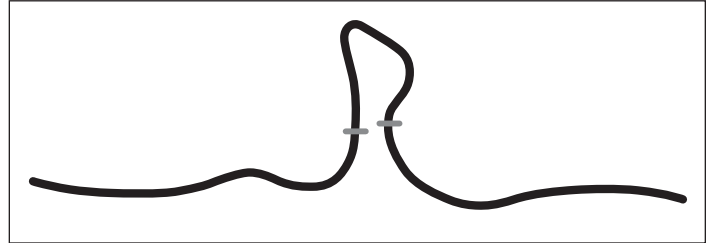

3. Use the round cable stripper to remove the outside protective wire jacket to expose the 4 individual color-coded wires. If you are unfamiliar with using a round cable stripper, please go to YouTube and search for videos on 'Using a Round Cable Stripper'. Or visit the specific brand of cable stripper's company website for detailed instructions.

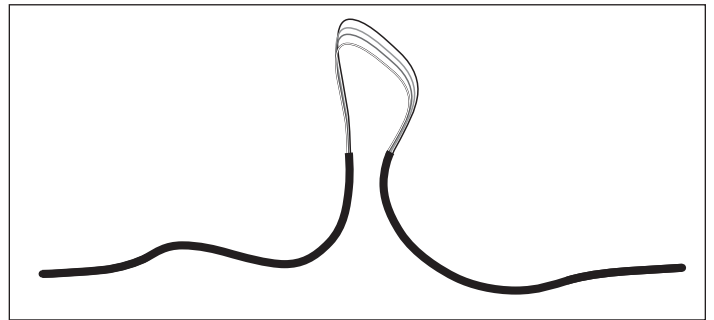

4. Use a wire tie to keep the wire loop intact and act as a strain relief.

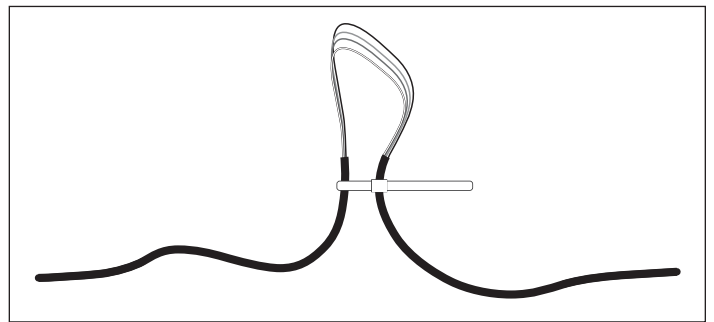

PLEASE NOTE: REGARDING THE 4 COLORED WIRES, THE RED (+) AND BLACK (-) ARE USED FOR THE RIGHT CHANNEL, WHITE (+) AND GREEN (-) FOR THE LEFT CHANNEL.

5. Cutting the wires. In this example, we want the first speaker to be connected to the right channel so we cut the red (+) and black (-) wires only. Leave the white and green wires intact.

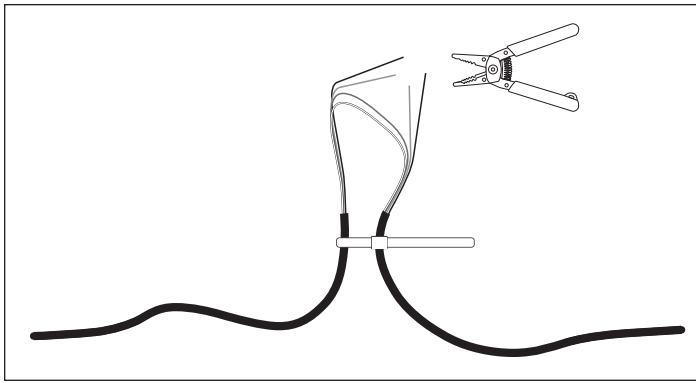

- Strip off 3/4 inch of insulation on the red and black wires to expose the copper conductor. Combine and twist the red wires from the amplifier, the first satellite and the wire running to the next speaker in a clock-wise motion.
- Secure these three wires using the provided silicone filled wire nuts, ensuring that NO COPPER is exposed.

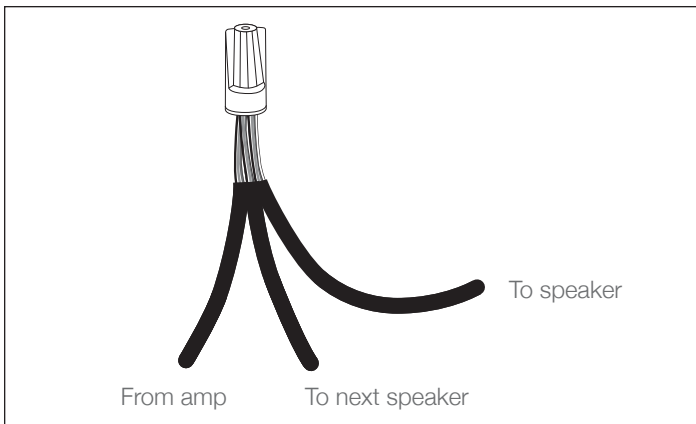

- Wrap the wire nut and surrounding wire connection in electrical tape to protect from moisture.
- At the next speaker, repeat steps 2 – 7 for the left channel using the white (+) and green (-) leaving the red (+) and black (-) wires intact.
- Continue the above steps for the remaining 6 speakers in the daisy-chain (see Figure 3).

IMPORTANT: BE SURE ONLY 4 SATELLITE SPEAKERS ARE CONNECTED TO EACH AMP CHANNEL; MIS-WIRING MAY RESULT IN AN UNACCEPTABLE LOAD WHICH COULD DAMAGE YOUR AMPLIFIER.

Connecting the Speakers Using a 2-Conductor Wire or Low Voltage Lighting Wire

- Pull the first pair of 2-conductor wire to the furthest speaker location, leaving it connected to the spool near the amplifier.
- Starting at the furthest speaker and every other speaker that follows, create a loop of wire approximately 6" in length, securing the loop with a wire tie.

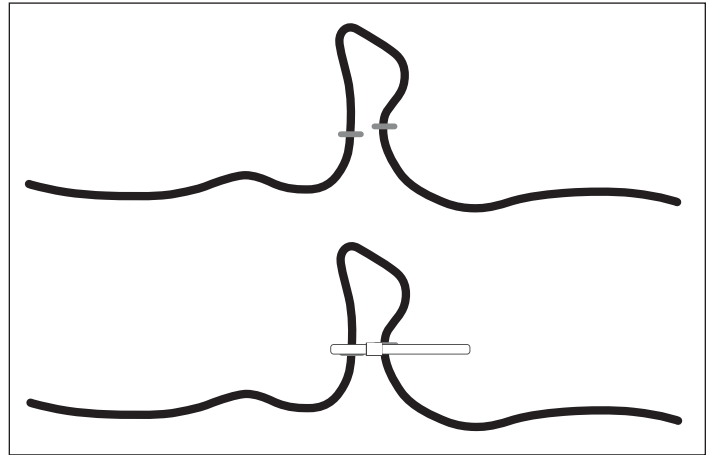

- Cut the wire at the last speaker location in the daisy-chain closest to the amplifier.
- Take the spool back to the starting point and pull a second 2-conductor wire to the furthest speaker location and repeat steps 1 and 2 (see Figure 4).
- Starting with the first speaker, cut the wire loop.

NOTE: IF NOT USING COLOR-CODED WIRE, NOTICE THAT ONE OF THE WIRES OUT OF THE PAIR WILL HAVE A DIFFERENT TEXTURE OR PRINTING ON IT. THIS WILL HELP IDENTIFY AND SEPARATE THE (+) FROM THE (-). FOR SIMPLICITY, USE THE WIRE WITH TEXTURE OR WRITING AS THE (+) AND THE OTHER AS THE (-). USE THIS POLARITY STANDARD WHEN CONNECTING ALL THE SPEAKERS.

- Strip the insulation on each wire to expose approximately 3/4" of copper. Combine and twist all the positive (+) wires together in a clockwise motion. Repeat this step for all the negative (-) wires.
- Secure the three wires together using the provided silicone filled wire nuts ensuring that NO COPPER is exposed (see Figure 5).
- Repeat steps 5– 7 for the remainder of the speakers.

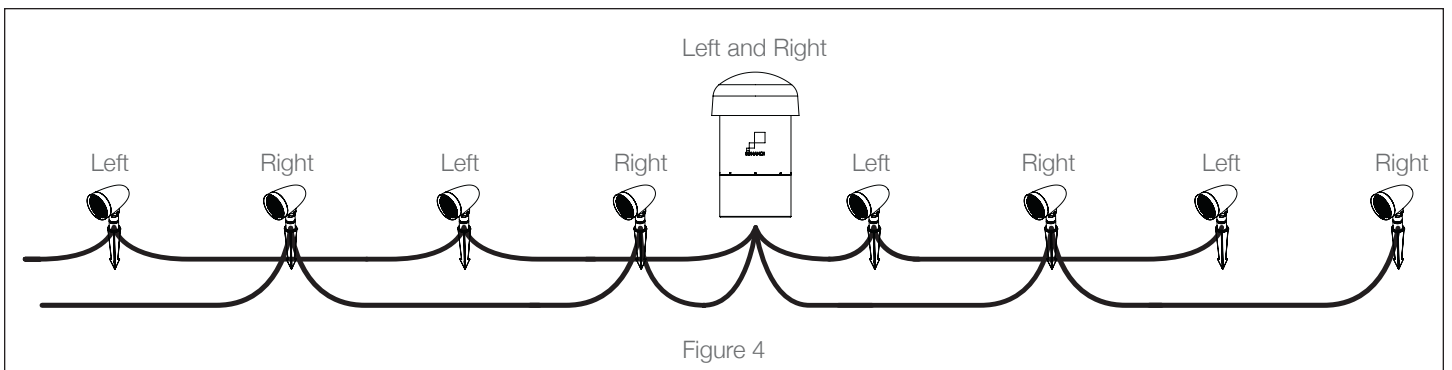

Subwoofer Wire Connection

The subwoofer features a dual voice coil driver with 4 wires, one pair for each of the amplifier channels. red (+) and black (-) are used for the right channel, white (+) and green (-) for the Left channel. The subwoofer can be connected at any point along the daisy chain e.g. beginning, middle, end or anywhere in-between. However, locating the subwoofer mid-way in the daisy chain will produce an equal amount of bass for the speakers on either side of the sub. The subwoofer needs to be connected in the same manner as the satellites speakers (see Figure 6).

IMPORTANT: THE SUBWOOFER HAS DUAL VOICE COILS, ONE FOR THE LEFT CHANNEL AND ONE FOR THE RIGHT CHANNEL,, IT IS CRITICAL THAT THE POSITIVE AND NEGATIVE WIRES BE CONNECTED CORRECTLY FOR BOTH CHANNELS. IF EITHER CHANNEL IS CONNECTED INCORRECTLY NO LOW FREQUENCY SOUND WILL BE PRODUCED.

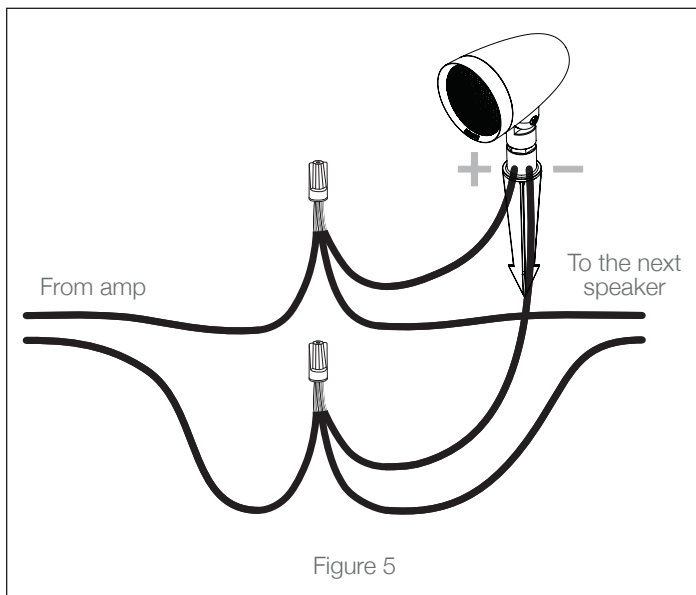

After all satellites and subwoofer connections are completed, connect the wires to your receiver or amplifier (see Figure 3 & Figure 5).

IMPORTANT: BE SURE NOT TO LET ANY STRAY '+' AND '-' STRANDS TOUCH EACH OTHER. TOUCHING STRANDS WILL CAUSE A SHORT-CIRCUIT WHICH COULD DAMAGE YOUR AMPLIFIER.

Turn your source and amplifier/reciever on and test the system with your favorite music. If the speakers are operating properly, refill the wire trench and enjoy your new Sonance Garden Series System.

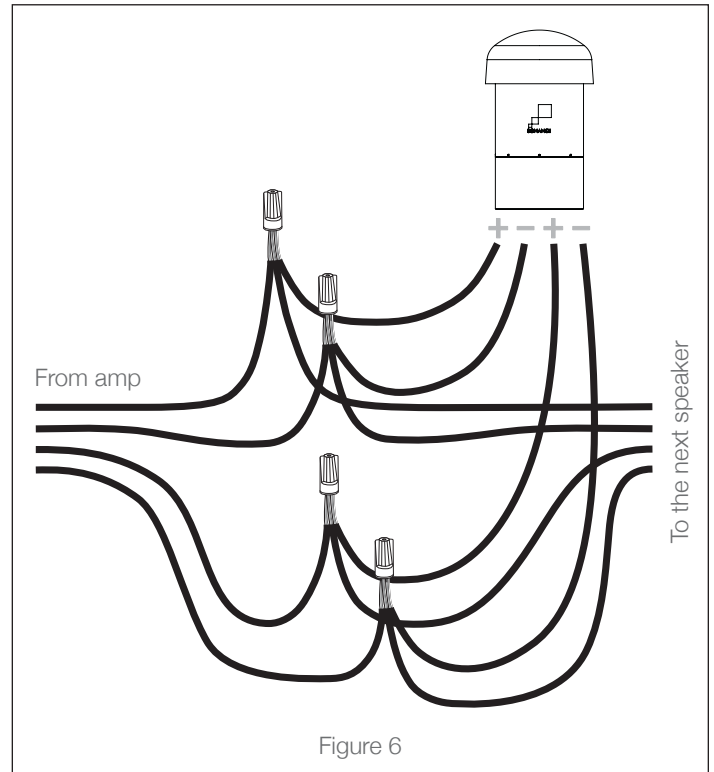

Specifications

SGS Satellite Speaker

Tweeter:	3/4" (19mm) Polyurethane dome
Woofers:	3.5" (98mm) Anodized aluminum cone & Santoprene™ surround
Frequency Response:	80Hz - 20kHz +/-3dB
Impedance:	30 Ohms nominal
Power Handling:	50 watts minimum; 200 watts maximum
Sensitivity:	87dB 2.83V / 1 meter
Enclosure Material:	Non-corrosive, high-heat ABS sealed enclosure
Mounting Threads:	1/2" NPS (National Pipe Standard)
Dimensions (L x Dia.):	6.5" L x 4.125" Dia. (165mm x 105mm)
Shipping Weight:	5.0lbs (2.4kg) each

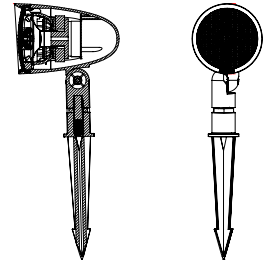

SGS Subwoofer

Woofers:	10" (254mm) dual voice coil, polypropylene & Santoprene surround
Frequency Response:	35Hz - 100Hz ±3dB
Crossover Frequency:	100Hz
Power Handling:	200 Watts
Sensitivity:	90dB Sensitivity @ 2.83V / 1 meter
Enclosure Material:	High Density Polyethylene (HDPE) non-corrosive sealed enclosure
Dimensions (LxDia.):	24.8" x 15" (630mm x 381mm)
Shipping Weight:	40 lbs (19kg)

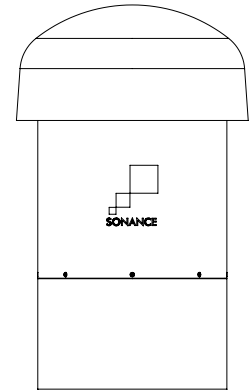

Speaker Wire Recommendations:

18 gauge - up to 100 ft. (30m) 16 gauge - up to 150 ft. (45m) 14 gauge - up to 280 ft. (85m)

LIMITED THREE (3) YEAR WARRANTY

Sonance warrants to the first end-user purchaser that this Sonance-brand product (product), when purchased from an authorized Sonance Dealer/Distributor, will be free from defective workmanship and materials for the period stated above. Sonance will at its option and expense during the warranty period, either repair the defect or replace the Product with a new or remanufactured Product or a reasonable equivalent.

EXCLUSIONS

TO THE EXTENT PERMITTED BY LAW, THE WARRANTY SET FORTH ABOVE IS IN LIEU OF, AND EXCLUSIVE OF, ALL OTHER WARRANTIES, EXPRESS OR IMPLIED, AND IS THE SOLE AND EXCLUSIVE WARRANTY PROVIDED BY SONANCE. ALL OTHER EXPRESS AND IMPLIED WARRANTIES, INCLUDING THE IMPLIED WARRANTIES OF MERCHANTABILITY, IMPLIED WARRANTY OF FITNESS FOR USE, AND IMPLIED WARRANTY OF FITNESS FOR A PARTICULAR PURPOSE ARE SPECIFICALLY EXCLUDED.

No one is authorized to make or modify any warranties on behalf of Sonance. The warranty stated above is the sole and exclusive remedy and Sonance's performance shall constitute full and final satisfaction of all obligations, liabilities and claims with respect to the Product.

IN ANY EVENT, SONANCE SHALL NOT BE LIABLE FOR CONSEQUENTIAL, INCIDENTAL, ECONOMIC, PROPERTY, BODILY INJURY, OR PERSONAL INJURY DAMAGES ARISING FROM THE PRODUCT, ANY BREACH OF THIS WARRANTY OR OTHERWISE.

This warranty statement gives you specific legal rights, and you may have other rights which vary from state to state. Some states do not allow the exclusion of implied warranties or limitations of remedies, so the above exclusions and limitations may not apply. If your state does not allow disclaimer of implied warranties, the duration of such implied warranties is limited to period of Sonance's express warranty.

Your Product Model and Description: Sonance Garden Series SGS System

Warranty Period for this Product: Three (3) years from the date on the original sales receipt or invoice or other satisfactory proof of purchase.

Additional Limitations and Exclusions from Warranty Coverage: The warranty described above is non-transferable, applies only to the initial installation of the Product, does not include installation of any repaired or replaced Product, does not include damage to allied or associated equipment which may result for any reason from use with this Product, and does not include labor or parts caused by accident, disaster, negligence, improper installation, misuse (e.g. overdriving the amplifier or speaker, excessive heat, cold or humidity), or from service or repair which has not been authorized by Sonance. Obtaining Authorized Service: To qualify for the warranty, you must contact your authorized Sonance Dealer/Installer or call Sonance Customer Service at (949) 492-7777 within the warranty period, must obtain a return merchandise number (RMA), and must deliver the Product to Sonance shipping prepaid during the warranty period, together with the original sales receipt, or invoice or other satisfactory proof of purchase.



©2019 Sonance. All rights reserved.

Sonance is a registered trademarks of Dana Innovations.

Due to continuous product improvement, all features and specifications are subject to change without notice.

For the latest Sonance product specification information visit our website: www.sonance.com

SONANCE • 991 Calle Amanecer • San Clemente, CA 92673 USA
(949) 492-7777 • FAX: (949) 361-5151 • Technical Support: (949) 492-7777